

GOVERNMENT OF ASSAM**FLOOD AND RIVER EROSION MANAGEMENT AGENCY OF ASSAM, (FREMAA)**

Address: 4th Floor, Assam Water Centre Basistha Chariali, NH 27 Guwahati, Assam-781029, Phone/Fax- (0361)2309896, Email: ceo-fremaa@assam.gov.in, Website: www.fremaa.assam.gov.in

No. FREMAA(P)/TECH/WB/56/2022/182/T-96

Date: 20/12/2023

REQUEST FOR QUOTATION (RFQ)**(One-Envelope Bidding Process with e-Procurement)**

The Chief Executive Officer, Flood & River Erosion Management Agency of Assam (FREMAA) invites Request for Quotation (RFQ) from reputed firms/company/registered contractors for the civil works as follows:

Name of Work	Approximate Value
Construction of Car Parking Shed at Assam Water Centre, Basistha, Guwahati-29	Rs. 13,59,000/-

Complete RFQ documents shall be available on website <http://fremaa.assam.gov.in> and www.assamtenders.gov.in from 22.12.2023. A pre-bid meeting for the aforementioned work is scheduled to be held on 29.12.2023 at 1PM (13:00HRS) in the Conference Hall of FREMAA.

Intending tenderers are required to register in the e-tender portal of the Assam Govt. www.assamtenders.gov.in and participate through e-tender portal only. The last date and time of submission of quotation is on 09.01.2024 at 2PM (14:00HRS)

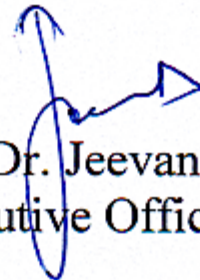

(Dr. Jeevan B, IAS)
Chief Executive Officer-FREMAA

Memo No. FREMAA(P)/TECH/WB/56/2022/

Date: 20/12/2023

Copy for necessary action to: -

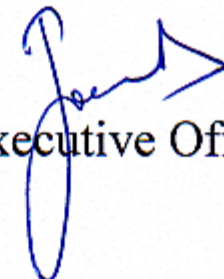
1. TO(C), FREMAA: For uploading the RFQ in e-Portal of Govt. of Assam viz <https://assamtenders.gov.in> and FREMAA website: www.fremaa.assam.gov.in

Chief Executive Officer-FREMAA

REQUEST FOR QUOTATIONS

Procurement of Works E-Procurement Notice

(Single-Envelope with e-Procurement Bidding Process)

Project : Assam Integrated River Basin Management Program (AIRBMP)

Contract Title : Construction of Car Parking Shed at Assam Water Centre, Basistha, Guwahati-29

RFQ No : FREMAA_CW5_CAR PARKING SHED

Notice For Quotation No: FREMAA(P)/TECH/WB/56/2022/182/T-96

Dated: 20/12/2023

Applicable Procurement Regulations Date: Nov 2020

1. Government of Assam through Government of India has received financing from the World Bank towards the cost of the AIRBMP Project and intends to apply part of the proceeds of this credit to eligible payments under the contract for which this request for quotations is issued. Flood and River Management Agency of Assam (FREMAA) invites quotations electronically from eligible bidders for construction of the following works:

Name of Work	Approximate Value	Period of Completion
Construction of Car Parking Shed at Assam Water Centre, Basistha, Guwahati-29	Rs. 13,59,000/-	60 days

2. This e-Procurement notice includes the following documents to facilitate preparation and submission of quotations, criteria for qualification, evaluation, and for award of contract; and relevant forms to be filled by the bidders. Implementing Agency has not issued a separate RFQ document for this purchase. The e-Procurement notice including the various documents and forms to be filled etc can be downloaded free of cost by logging on to the website www.fremaa.assam.gov.in. The bidders would be required to register in the website which is free of cost.

- i. Detailed Bill of Quantities; (Annexure I)
- ii. Layout Drawings of the Works; (Annexure 3)
- iii. Technical Specifications as mentioned in the BOQ;
- iv. Instructions to Bidders;
- v. Qualification Information;
- vi. Format for Submission of Quotation;
- vii. Criteria for Evaluation and Award of Contract;
- viii. Relevant Forms; and
- ix. Draft Contract Agreement format which will be used for finalizing the agreement for this Contract.

3. For submission of Quotation, the Bidder is required to have Digital Signature Certificate (DSC) from one of the Certifying Authorities authorized by Government of India for issuing DSC. Bidders can see the list of licensed CA's from the link (www.cca.gov.in). Bidders who have not

obtained the user ID and password for participating in e-procurement in this Project, may obtain the same from the website: <https://assamtenders.gov.in>

4. Quotations, both Technical Part and Financial Part, shall be submitted on or before **09.01.2024 at 2PM (14:00 HRS)**. The prospective bidders may seek queries/clarification from (~~22.12.2023 to 28.12.2023 at 17:00 HRS~~) through e procurement portal only **& in this regard a pre-bid meeting will be held on 29.12.2023 at 1PM (13:00 HRS)** in the conference hall of FREMAA. Virtual link will be sent to the bidder/quotationer who desires to participate and they may send request to the email id: ceo-fremaa@assam.gov.in on or before **28.12.2023 at 5PM (17:00 HRS)**. Any quotation or modifications to quotation received outside e-procurement system will not be considered. The electronic bidding system would not allow late submission of quotations. The Quotations will be opened online on or after **09.01.2024 at 3PM (15:00 HRS)**, which can also be viewed by the bidders online. The electronic summary of quotation opening of technical part will be generated and uploaded online.

5. If the Purchaser's office happens to be closed on the date of opening of the Quotations as specified, the Quotations will be opened on the next working day at the same time.

6. Other details can be seen in the RFQ document. The implementing agency shall not be held liable for any delays due to system failure beyond its control. A Bidder requiring any clarification of the RFQ document may notify the Implementing agency online or may visit the office of the implementing agency at the address given below.

Flood and River Erosion Management Agency of Assam

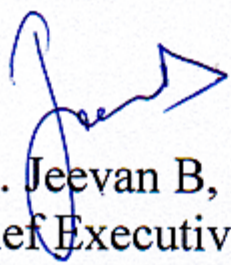

(Dr. Jeevan B, IAS)
Chief Executive Officer
Assam Water Centre, 4th Floor,
Basistha Chariali, Ghy. – 29

(<https://fremaa.assam.gov.in/>)

Instructions to Bidders

SECTION - A

1. Scope of Works

Flood and River Erosion Management Agency of Assam invites quotations for the construction of works as detailed in the table given below:

SL No	Brief Description of the work	Approximate Value (Rs)	Period of Completion (Days)
A	Construction of Car Parking Shed at Assam Water Centre, Basistha, Guwahati-29	Rs. 13,59,000/-	60 days

The successful bidder will be expected to complete the works by the intended completion date specified above.

2. Qualification of the bidder

2.1 Qualification Information to be provided by the Bidder: The bidder shall provide information on his qualification which shall include: -

- a) Total monetary value of civil construction works of building /building renovation, refurbishment executed by the firm/company for each year of the last 3 years 2020-21, 2021-22 and 2022-23.
- b) List of works (similar to the works described in Para 1) completed satisfactorily as a prime contractor during the last 3 years (2020-21, 2021-22 and 2022-23), enclosing certificates from the respective Employers in support of experience claimed along with the Employers' Employers' office address, contact numbers and email id.
- c) Report on his financial standing, along with last 3 years' (2020-21, 2021-22 and 2022-23) financial statements/ Profit and Loss Statements from audited Balance Sheet. And
- d) Details of any litigation, during the last 3 years (2020-21, 2021-22 and 2022-23) in which the bidder is involved, the parties concerned, and disputed amount or award in each case (Give details of both completed and pending cases

Additional information required as follows:

- e) Certification of Registration as a Civil Contractor of any Department of Govt. of Assam/any State Govt. Department of India.
- f) PAN, GST Registration, Income Tax Return (ITR) etc.
- g) Name of authorized person along with Power of attorney to sign the quotation and contract

Supporting document in respect of Sl. no from 2.1(a) to 2.1(g) above shall be submitted as per format provided in 1. Format for Qualification Information under Section B of this RFQ.

2.2 Qualification Criteria:

To qualify for award of the contract the bidder: -

a) Should have satisfactorily completed as a prime contractor/sub-contractor in Govt./ Public Sector undertaking /Govt undertaking in the last 3 (Three) years as detailed below:

<i>Sl. No</i>	<i>Brief Description of the Works</i>	<i>Value of single Work Order of similar nature completed successfully</i>
1	Construction of Car Parking Shed at Assam Water Centre, Basistha, Guwahati-29	One work of similar nature of minimum order value of Rs 10,90,000/- and 2 works of min order value of Rs 8,15,000/- each.

Similar nature of work means experience in construction of car parking shed which should include the items as mentioned below:

SI No	ITEMS
1	FABRICATION WORKS
2	STEEL STRUCTURAL WORKS
3	TRUSS WORKS

Note: Work order supported by Bill of Quantities (BoQ) & Completion certificate/Payment receipt certificate & minimum 90% payment receipt certificate (in case of similar nature of work in progress) issued by the client (not below the rank of Executive Engineer) shall be submitted in support of claim of the similar nature of work successfully executed as per Sl. No. 2.2.

3. Eligibility – Conflict of Interest: A Bidder (a) shall not participate in more than one Quotation; (b) shall not have conflict of interest as defined in the Bank’s Procurement Regulations and (c) should not have been (i) temporarily suspended or debarred by the World Bank Group in compliance with the Bank’s Anti-Corruption Guidelines and its Sanctions Framework.

4. Clarifications & Amendments: If the Employer receives any request for clarification of this RFQ document, it will upload its response together with any amendment to this document, on the e-procurement portal for information of all Bidders. Bidders should check on the e- procurement system, for any amendments to this RFQ document.

5. Quotation Prices

a) The quotation shall be for construction of the whole works as described in the Bill of quantities, drawings and technical specifications. Corrections, if any, in the quotation shall be carried out by editing the information before electronic submission on e - Procurement Portal.

b) All duties, taxes and other levies payable by the contractor under the contract shall be included in the total price.

c) The rates quoted by the bidder shall be fixed for the duration of the contract and shall not be subject to adjustment on any account.

d) The rates should be quoted in Indian Rupees only.

6. Preparation of Quotations

6.1 The bidders/quotationer is advised to visit the site of works at his own expense and obtain all information that may be necessary for preparing the quotation.

The contact person name: Chief Technical Officer (CTO), Mobile No: 9435041754

Office Address: FREMAA at 4th Floor of Assam Water Centre, Basistha Chariali) Guwhati-29

6.2 Each bidder shall submit only one quotation. Bidders shall not contact other Bidders on matters relating to this quotation.

6.3 The quotation shall comprise two Parts, namely the Technical Part and the Financial Part. Both Parts shall be submitted online simultaneously.

6.4 The Technical Part of Quotation shall comprise the following:

- a) **Letter of Quotation – Technical Part** as per Format given in Section B;
- (b) **Authorization:** Power of Attorney of signatory of Quotation (Paragraph 1.1 of Qualification Information);
- (c) **Annual Turnover:** Confirmation showing Annual Turnover in civil engineering construction works of similar nature in the last three financial years. [ITB Clause 2.1 (a)];
- (d) **Qualifications:**
 - (i) Qualification information and supporting documents relating to similar nature of works executed and payments received. (ITB Clause 2.1 (b) and paragraph 1.3 of Qualification Information);
 - (ii) Details of proposed sub-contractors; (Paragraph 1.4 of Qualification Information); and
 - (iii) Other details listed in Paragraphs 1.6 and 1.7 of the Qualification Information Form;

- (e) **Complete address** and contact details of the Bidder having the following information:

Name of Firm:

Address for communication:

Telephone No(s): Office

Mobile No.

Facsimile (FAX) No.

Electronic Mail Identification (E-mail ID)

(f) The Technical Part of Quotation shall not include any financial information related to the Quotation price. Where material financial information related to the Quotation price is contained in the Technical Part of Quotation, the Quotation shall be declared non-responsive.

6.5 The Financial Part of Quotation shall comprise the following:

- (a) **Letter of Quotation** - Financial Part;
- (b) **Priced Bill of Quantities:** (using the BOQ uploaded with the RFQ document) wherein the rates shall be entered online.

6.6 Signing of Quotations: The name and position held by each person signing the quotation and related documents must be typed or printed below the signature.

6.7 Deadline for Submission of Quotations: Quotations must be uploaded online no later than the deadline for submission of quotations viz. time 14:00 (hours) and date 09.01.2024 as per server time. A Bidder may modify its Quotation any number of times by using the appropriate option on the e-Procurement Portal, before the deadline for submission of Quotations.

6.8 Validity of Quotation: Quotation shall remain valid for a period not less than 45 days after the deadline date specified for submission.

7. Quotation Submission:

- (a) The Letter of Quotation – Technical Part, and Letter of Quotation – Financial Part shall be filled, signed and scanned copies shall be uploaded along with the Priced Bill of Quantities that shall be entered using the Forms available online, without any alterations. All blank spaces shall be filled in with the information requested. Scanned copies of all other documents shall also be uploaded on the e-procurement website.
- (b) All documents are required to be signed digitally by the Bidder. The System generates a Unique Quotation Identification Number, time stamped as per server time, as an acknowledgement for Quotation submission. Detailed guidelines for viewing and submission of Quotations online are given in the website.

8. Online Opening and Evaluation of Technical Parts of Quotations: The ‘Technical Part’ and ‘Financial Part’ of the Quotations will be opened simultaneously online on the specified date and time. This can also be viewed by the bidders online, and electronic summary of quotation opening of technical part will be generated and uploaded online.

- (a) The Employer shall examine the technical part of the quotation to determine whether the quotation (a) has been properly signed (Clause 6.6); (b) meets the eligibility criteria

(Clause 3); (c) is substantially responsive to the requirements of the RFQ document; and (d) meets the qualification criteria specified in ITB Clause 2.

- (b) Only Quotations that are both substantially responsive to the RFQ document, and meet all Qualification Criteria shall qualify for evaluation of the Financial Parts.

9. Evaluation of Financial Part of Quotation:

- (a) The Employer shall examine and confirm that Letter of Quotation – Financial Part and Priced Bill of Quantities are in accordance with the requirements specified in the RFQ document. If any of these documents or information is missing, the offer shall be rejected.
- (b) During the evaluation of Financial Parts of Quotation, the substantial responsiveness of the Quotations will be further determined with respect to those RFQ conditions that were not examined in evaluation of Technical Parts of Quotations.

10. Award of contract

The Employer will award the contract to the bidder whose quotation has been determined to be substantially responsive and who has offered the lowest evaluated quotation price and who meets the specified qualification criteria. However, in case of abnormally low quoted or frontloaded quotation, justification on the same may be asked to bidder based on which award of contract may be accorded. **In case of abnormally lowest evaluated price, the bidder will have to provide additional performance security @10% as decided by the client else next ranked evaluated bidder will be eligible for consideration of award of contract.**

- 10.1** Notwithstanding the above, the Employer reserves the right to accept or reject any quotations and to cancel the bidding process and reject all quotations at any time prior to the award of contract.

- 10.2** The bidder whose quotation is accepted will be notified of the award of contract by the Employer prior to expiration of the quotation validity period

11. Performance Security

Within 15 days of receiving letter of acceptance, the successful bidder shall deliver to the Chief Executive Officer, FREMAA the performance security (in the form of bank guarantee in favour of the Chief Executive Officer, FREMAA) for an amount equivalent of 5% of the contract price. The Performance Security shall be valid till the expiry of the period of maintenance of the work, specified in Clause 12. Failure of the successful Bidder to furnish performance security and to sign the agreement within the period stipulated shall constitute sufficient grounds for annulment of award and debarring the bidder from participation in bidding for works by the Employer for a period of one year, in which case the Employer may make the award to the next lowest evaluated bidder or seek quotations afresh.

12. Period of Maintenance:

The “Period of Maintenance” for the work is one year from the date of taking over possession. During the period of maintenance, the contractor will be responsible for rectifying any defects in construction free of cost to the Employer.

13. Supply of all construction materials & goods/ equipment should be as per the technical specifications mentioned in the Bill of Quantities (ISI certification marked goods wherever available) shall be the responsibility of the contractor. Employer will not issue any material/equipment.

.....

SECTION-B

- 1. Format for Qualification Information.**
- 2. Format for Submission of Quotation.**
- 3. Format of Letter of Acceptance.**

QUALIFICATION INFORMATION

1 For Individual Bidders:

1.1 Principal place of business: _____

(Attach Registration certificate as civil contractor)

b) Power of attorney of signatory of Quotation.

[Attach copy]

1.2 Total value of Civil Engineering 2022-23 _____

Construction work of building 2021-22 _____

in Govt organizations etc. performed

in the last three years (in Rs. Lakhs) 2020-21 _____

1.3 Work performed as prime contractor (in the same name) on works of a similar nature over the last three years.

<u>Project Name</u>	<u>Name of Employer</u>	<u>Descrip- tion of work</u>	<u>Contract No.</u>	<u>Value of contract (Rs. Lakhs)</u>	<u>Date of issue of work order</u>	<u>Stipulated period of completion</u>	<u>Actual Date of Completion</u>	<u>Remarks explaining reasons for delay and work completed</u>
---------------------	-------------------------	------------------------------	---------------------	--------------------------------------	------------------------------------	--	----------------------------------	--

Existing commitments and on-going works:

Description of Work	Place & State	Contract No. & Date	Value of Contract (Rs. Lakhs)	Stipulated period of completion	Value of works* remaining to be completed (Rs. Lakhs)	Anticipated date of completion
(1)	(2)	(3)	(4)	(5)	(6)	(7)

* *Enclose a certificate from the Engineer concerned for completion as well as value of pending works.*

1.4 Proposed subcontracts and firms involved.

Sections of the works	Value of Sub-contract	Sub-contractor (name & address)	Experience in similar work
*	*	*	*
	*	*	
	*	*	*
*	*	*	
	*	*	*
	*		
*			

1.5 Evidence of access to financial resources to meet the requirements of working capital: cash in hand, lines of credit, etc. List them below and attach copies of support documents.

1.6 Name, address, and telephone, telex, and fax numbers of the Bidders' bankers who may provide references if contacted by the Employer.

1.7 Information on litigation history in which the Bidder is involved.

Name of the work	Agreement number/date	Name & address of Employer	Contract Value in Rs	Cause of dispute	Amount Disputed	Remarks showing present status

1.8 Additional information (if any):

Letter of Quotation–Technical Part

The Bidder must prepare the Letter of Quotation on stationery with its letterhead clearly showing the Bidder's complete name and address. The italicized text is for Bidder's guidance in preparing these forms and shall be deleted from the final products.

Description of the Works*: Construction of Car Parking Shed at Assam Water Centre, Basistha, Guwahati-29

RFQ No.:[insert identification]

Our Reference: No..... Dated.....

To: (Employer's Name and Address)

Subject : Construction of.....
.....

Reference : Letter No.....dated.....from.....

Sir,

1. We, the undersigned, hereby submit our Quotation in two parts, namely:

- (a) Technical Part; and
- (b) Financial Part

2. In submitting our Quotation, we make the following declarations:

- (a) **No reservations:** We have examined and have no reservations to the RFQ document.
- (b) **Conformity:** We offer to execute the subject work in conformity with the RFQ document and in accordance with the Period of Completion specified in Section A.;

- (c) **Quotation Validity Period:** Our Quotation shall be valid for the period of 45 days, from the deadline fixed for the Quotation submission;
- (d) **Eligibility:** We meet the eligibility requirements and have no conflict of interest, we are not participating in more than one quotation in this bidding process, and we have not been temporarily suspended or debarred by the World Bank.
- (e) **Fraud and Corruption:** We hereby certify that we have taken steps to ensure that no person acting for us or on our behalf will engage in any type of corrupt, fraudulent, collusive, coercive, or obstructive practices.
- (f) **ESHS/GBV Compliance:** We hereby undertake to comply with (i) the applicable Laws/ Rules/ Regulations for protection of environment, public health and safety; (ii) the regulatory authority conditions (if any) attached to any permits or approvals for the project; and (iii) the Management Strategies and Implementation Plan (MSIP) to manage the Environmental, Social (including sexual exploitation and abuse (SEA) and gender based violence (GBV)), Health and Safety (ESHS) risks, and ESHS Code of Conduct, (if any prescribed by the Employer), that will apply to us, our employees and all subcontractors.

Yours faithfully,

Authorized Signature : Date: _____

Name & Title of Signatory : _____

In the capacity of *[insert legal capacity of person signing the Letter of Quotation]*

Name of Bidder : _____

Address : _____

Dated on _____ day of _____, _____ *[insert date of signing]*

* ***To be filled in by the Employer before issue of the Letter of Invitation.***

** ***To be filled in by the Bidder, together with his particulars and date of submission at the bottom of this Form.***

Letter of Quotation–Financial Part

The Bidder must prepare the Letter of Quotation on stationery with its letterhead clearly showing the Bidder's complete name and address. The italicized text is for Bidder's guidance in preparing these forms and shall be deleted from the final products.

Description of the Works*: Construction of Car Parking Shed at Assam Water Centre, Basistha,
Guwahati-29

RFQ No.: *[insert identification]*

Our Reference: No..... Dated.....

To:

(Employer's name and address)

Subject: Construction of.....

Sir,

1. We, the undersigned, hereby submit the second part of our Quotation, the Financial Part including the Quotation Price and Bill of Quantities. In submitting our Financial Part we make the following additional declarations:

(a) **Validity:** Our Quotation shall be valid for the period of 45 days from the deadline fixed for the Quotation submission;

(b) **Quotation Price:** The total price of our Quotation including any unconditional discounts, offered in accordance with the Conditions of Contract is at percentage above / below the estimated rates, i.e., for a total Contract Price of –

Rs.** _____ [in figures]

Rs. _____ [in words];

(c) **Commissions, gratuities and fees:** We have paid, or will pay the following commissions, gratuities, or fees with respect to the Bidding process or execution of the Contract: *[insert complete name of each Recipient, its full address, the reason for which each commission or gratuity was paid and the amount and currency of each such commission or gratuity. If none has been paid or is to be paid, indicate "none."]*

Yours faithfully,

Authorized Signature

Name & Title of Signatory _____

In the capacity of *[insert legal capacity of person signing the Letter of Quotation]*

Name of Bidder _____

Address _____

Dated on _____ day of _____, _____ *[insert date of signing]*

To be filled in by the Employer before issue of the Letter of Invitation.

**** *To be filled in by the Bidder, together with his particulars and date of submission at the bottom of this Form***

**LETTER OF ACCEPTANCE
CUM NOTICE TO PROCEED WITH THE WORK**

(LETTERHEAD OF THE EMPLOYER)

Dated: - _____

To: - _____ [Name and address of the Contractor]

Dear Sirs,

This is to notify you that your quotation dated _____ for execution of the _____ for the contract price of Rupees _____ [amount in words and figures], is hereby accepted by us.

You are hereby requested to furnish performance security for an amount of Rs.

_____ (Equivalent to 5% of the contract price) within 15 days of the receipt of the letter. The Performance Security in the form of Bank guarantee or a Bank draft in favour of (Employer) shall be valid till the expiry of the period of maintenance i.e. up to _____. Failure to furnish the Performance Security will entail cancellation of the award of contract.

You are also requested to sign the agreement form and proceed with the work not later than

_____ under the instructions of the Engineer,

_____ and ensure its completion within the contract period.

With the issuance of this acceptance letter and your furnishing the required Performance Security, the contract, for the above said work, stands concluded.

Yours faithfully,
Authorized Signature

**Name and title of Signatory of
Employer**

Draft Contract Agreement form for Construction through National Shopping

ARTICLES OF CONTRACT AGREEMENT

1. This deed of agreement is made in the form of agreement on _____ day _____ month _____ 20____, between the _____ (Employer) or his authorized representative (hereinafter referred to as the first party) and _____ (Name of the Contractor), S/O _____ resident of _____ (hereinafter referred to as the second party), to execute the work of construction of _____ (hereinafter referred to as works) on the following terms and conditions.

2. Contract Price

The total Contract Price for the works (hereinafter referred to as the “total price”) is Rs. _____ as reflected in Annexure - 1.

3. Payments under its contract:

3.1 Payments to the second party for the construction work will be released by the first party in the following manner: -

i) 30% Payment	i) On Completion of 40% works measured as completed on pro rata basis duly certified by the Engineer i/c of the client.
ii) Next 40% payment	ii) On Completion of 40% works measured as completed on pro rata basis duly certified by the Engineer i/c of the client.
iii) Balance 30% payment	iii) On Completion of 20% works measured as completed and after possession/handover of the completed works in all respect (including successful testing & commissioning of the work) duly certified by the Engineer i/c of the client

Retention Money from the Full and Final Bill	5% Retention Money to be deducted from the Full and Final bill and shall be reimbursed to the contractor after completion of defect liability period of Six Months.
--	---

3.2 Payments will be made by the first party:

- a. on the second party submitting a completion report of the allotted work; and
 - b. on certification of the invoice by the engineer nominated by the first party with respect to quality/quantity of works executed in the format in Annexure - 2;
4. The second party, on the works reaching each stage of construction, issue a notice to the first party or the Engineer nominated by the first party (who is responsible for supervising the contractor, administering the contract, certifying the payments due to the contractor, issuing and valuing variations to the contract, awarding extensions of time etc.), to visit the site for certification of stage completion. Within 7 days of the receipt of such notice, the first party or the engineer nominated by it, will ensure issue of stage completion certificate after due verification.

5. Completion time

The works should be completed in from the date of this Agreement. In exceptional circumstances, the time period stated in this clause may be extended in writing by mutual consent of both the parties.

6. If any of the compensation events mentioned below would prevent the work being completed by the intended completion date, the first party will decide on the intended completion date being extended by a suitable period:
- a) The first party does not give access to the site or a part thereof by the agreed period.
 - b) The first party orders a delay or does not issue completed drawings, specifications or instructions for execution of the work on time.
 - c) Ground conditions are substantially more adverse than could reasonably have been assumed before issue of letter of acceptance and from information provided to second party or from visual inspection of the site.
 - d) Payments due to the second party are delayed without reason.
 - e) Certification for stage completion of the work is delayed unreasonably.

7. Any willful delay on the part of the second party in completing the construction within the stipulated period will render him liable to pay liquidated damages. @ 0.05% per day which will be deducted from payments due to him. The first party may cancel the contract and take recourse to such other action as deemed appropriate once the total amount of liquidated damages exceeds 3 % of the contract amount.

Duties and responsibilities of the first party

- 8.1 The first party shall be responsible for providing regular and frequent supervision and guidance to the second party for carrying out the works as per specifications. This will include written guidelines and regular site visit of the authorized personnel of the first party, for checking quality of material and construction to ensure that it is as per the norms.
- 8.2 The first party shall supply 3 sets of drawings, specifications and guidelines to the second party for the proposed works.
- 8.3 Possession of the site will be handed over to the second party within 10 days of signing of the agreement.
- 8.4 The Engineer or such other person as may be authorized by the first party shall hold meeting once in seven days where the second party or his representative at site will submit the latest information including progress report and difficulties if any, in the execution of the work. The whole team may jointly inspect the site on a particular day to take stock of activities.
- 8.5 The Engineer shall record his observations/instructions at the time of his site visit in a site register maintained by the second party. The second party will carry out the instructions and promptly rectify any deviations pointed out by the engineer. If the deviations are not rectified, within the time specified in the Engineer's notice, the first party as well as the engineer nominated by it, may instruct stoppage or suspension of the construction. It shall thereupon be open to the first party or the engineer to have the deviations rectified at the cost of the second party.

9. Duties and responsibilities of the second party

- 9.1 The second party shall:
 - a) Take up the works and arrange for its completion within the time period stipulated in Clause 5;
 - b) Employ suitable skilled persons to carry out the works;
 - c) Regularly supervise and monitor the progress of work;

- d) Abide by the technical suggestions/direction of supervisory personnel including engineers etc. regarding building construction;
- e) Be responsible for bringing any discrepancy to the notice of the representative of the first party and seek necessary clarification;
- f) Ensure that the work is carried out in accordance with specifications, drawings and within the total of the contract amount without any cost escalation;
- g) Keep the first party informed about the progress of work;
- h) Be responsible for all security and watch and ward arrangements at site till handing over of the building to the first party; and
- i) Maintain necessary insurance against loss of materials/cash, etc. or workman disability compensation claims of the personnel deployed on the works as well as third party claims.
- j) Pay all duties, taxes and other levies payable by construction agencies as per law under the contract (First party will effect deduction (TDS) from running bills in respect of such taxes as may be imposed under the law).

10. Variations / Extra Items

The works shall be carried out by the second party in accordance with the approved drawings and specifications. However, if, on account of site conditions or any other factors, variations are considered necessary, the following procedure shall be followed: -

- a) The second party shall provide the Engineer with a quotation for carrying out the Variation when requested to do so by the Engineer. The Engineer shall assess the quotation, which shall be given within seven days of the request before the Variation is ordered.
- b) If the quotation given by the second party is unreasonable, the Engineer may order the Variation and make a change to the Contract Price which shall be based on Engineer's own forecast of the effects of the Variation on the Contractor's costs.
- c) The second party shall not be entitled to additional payment for costs which could have been avoided by giving early warning.

11. Securities

The Performance Security (Bank Guarantee from a Nationalized or Scheduled Bank in India in the format attached) shall be provided to the Employer no later than the date specified in the Letter of Acceptance and shall be issued in an amount and form and by a bank or surety

acceptable to the Employer. The Performance Security shall be valid until a date 28 days from the date of issue of the Certificate of Completion in the case of a Bank Guarantee.

12. Termination

12.1 The Employer may terminate the Contract if the other party causes a fundamental breach of the Contract.

12.2 Fundamental breaches of Contract include, but shall not be limited to the following:

- (a) The contractor stops work for 28 days and the stoppage has not been authorized by the Engineer;
- (b) The Contractor has become bankrupt or goes into liquidation other than for a reconstruction or amalgamation;
- (c) The Engineer gives Notice that failure to correct a particular Defect is a fundamental breach of Contract and the Contractor fails to correct it within a reasonable period of time determined by the Engineer;
- (d) The Contractor does not maintain a security which is required;
- (e) The Contractor has delayed the completion of the Works by the number of days for which the maximum amount of liquidated damages can be paid, as defined in the Clause 7 of this agreement

12.3 Notwithstanding the above, the Employer may terminate the Contract for convenience.

12.4 If the Contract is terminated the Contractor shall stop work immediately, make the Site safe and secure, and leave the Site as soon as reasonably possible.

13. Payment upon Termination

13.1 If the Contract is terminated because of a fundamental breach of Contract by the Contractor, the Engineer shall issue a certificate for the value of the work done less advance payments received up to the date of the issue of the certificate, less other recoveries due in terms of the contract, less taxes due to be deducted at source as per applicable law.

13.2 If the Contract is terminated at the Employer's convenience, the Engineer shall issue a certificate for the value of the work done, the reasonable cost of removal of Equipment, repatriation of the Contractor's personnel employed solely on the Works, and the Contractor's costs of protecting and securing the Works and less advance

payments received up to the date of the certificate, less other recoveries due in terms of the contract and less taxes due to be deducted at source as per applicable law.

14. Dispute settlement

If over the works, any dispute arises between the two parties, relating to any aspects of this Agreement, the parties shall first attempt to settle the dispute through mutual and amicable consultation.

In the event of agreement not being reached, the matter will be referred for arbitration by a Sole Arbitrator not below the level of retired Superintending Engineer, PWD to be appointed by the first party. The Arbitration will be conducted in accordance with the Arbitration and Conciliation Act, 1996. The decision of the Arbitrator shall be final and binding on both the parties. The Arbitrator shall give his award/decision within 60 days of start of proceedings.

The Priced Bill of Quantities (Annexure 1), Format of Certificate (Annexure 2) and Specification and Drawings (Annexure 3) are attached.

Signed and delivered by Sri. _____ for and on behalf of the Contractor

In the presence of the Witness:

i)

ii)

SIGNATURE

Signed and delivered by Dr. Jeevan B, IAS, Chief Executive Officer of Flood & River Erosion Management Agency of Assam (FREMAA) for an on behalf of the Government.

In the presence of the Witness:

i)

ii)

SIGNATURE

BILL OF QUANTITIES

(Note for Bidders: The Bill of Quantities (BoQ) are already available in the financial folder of e-procurement portal in which bidder shall quote the rates. Manually quoted rates will not be acceptable for evaluation and the bid will be declared as non-responsive

Format of certificate

Certified that the works up to ----- stage (as defined in Clause 3.1 of the Agreement) in respect of construction of ----- at -----
----- have been executed satisfactorily in accordance with the terms and conditions of the agreement and as per approved drawings and technical specifications.

Signature

Name & Designation

(Official address)

Place:

Date:

Office seal

Specification and Drawings

- 1. Specifications are available in Bill of Quantities (BoQ)**
- 2. Drawings (Attached)**

104544



134901

134604

SITE PLAN
SCALE = 1:100

 **CAR SHED (PARKING)**

Saint Domingo
 Dy. EO (ARCH.)

BSU
 (1510)

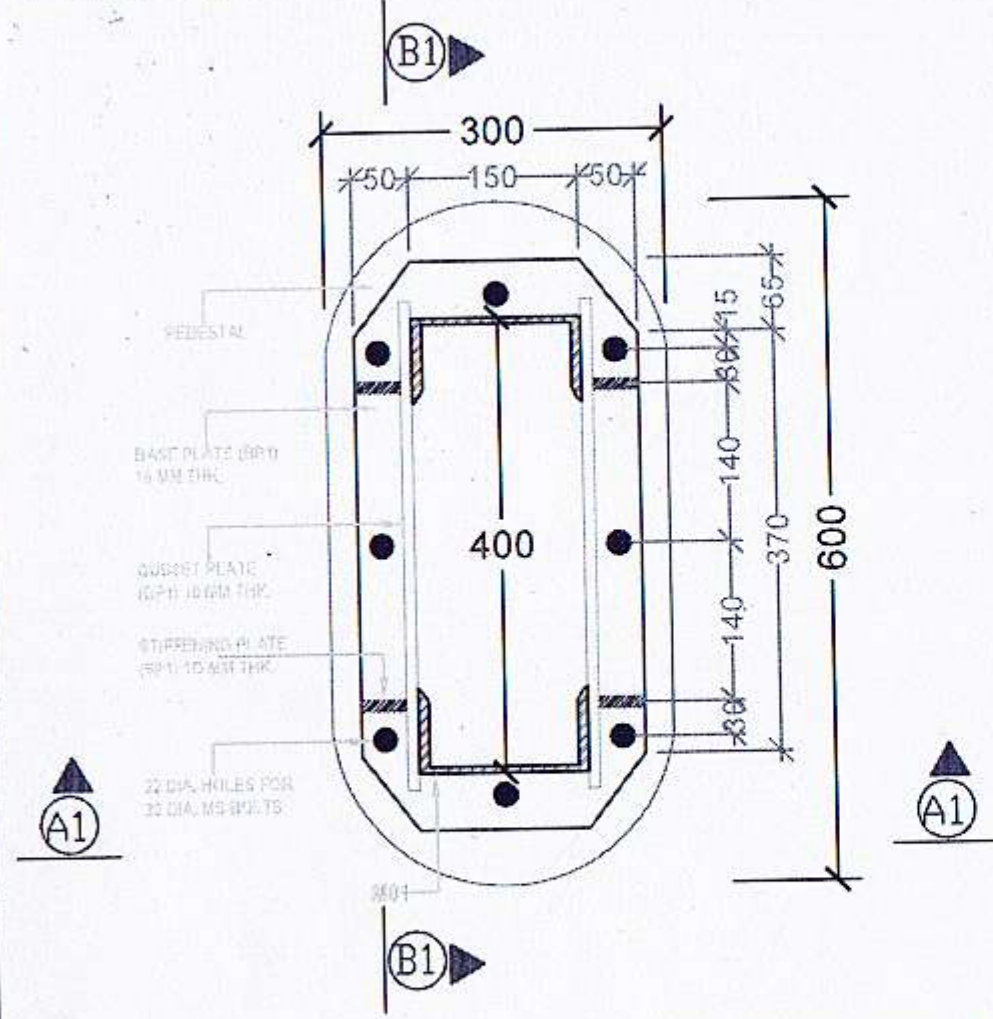

LAYOUT OF BASE PLATE (BP1) AT THE PEDESTAL

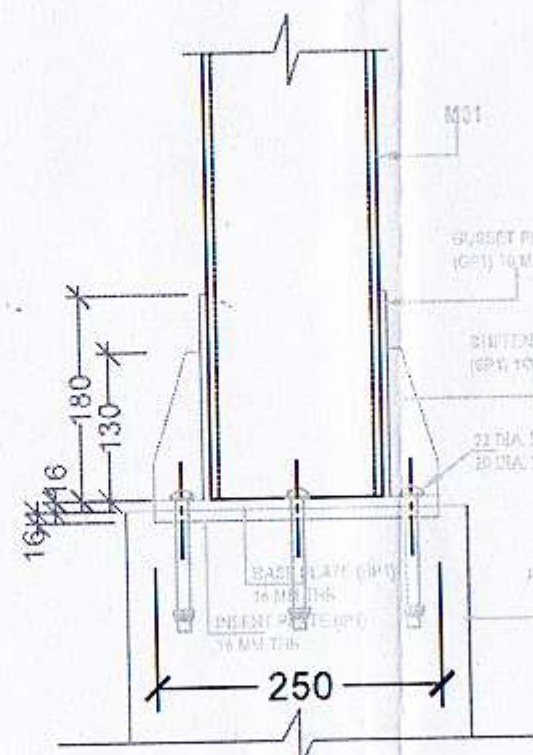

VIEW A1-A1 THROUGH THE BASE PLATE (BP1)

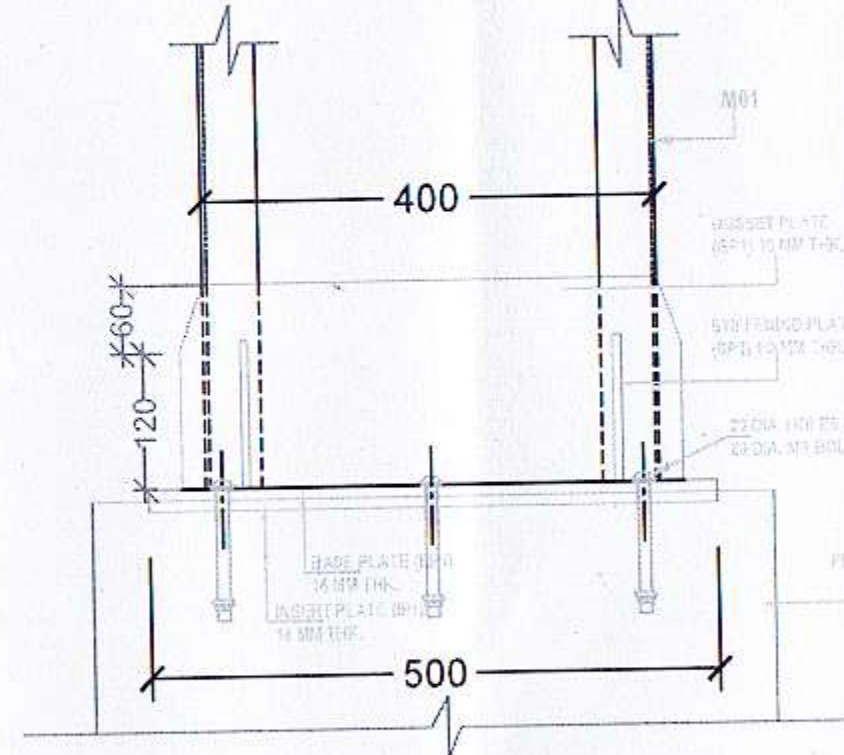

VIEW B1-B1 THROUGH THE BASE PLATE (BP1)

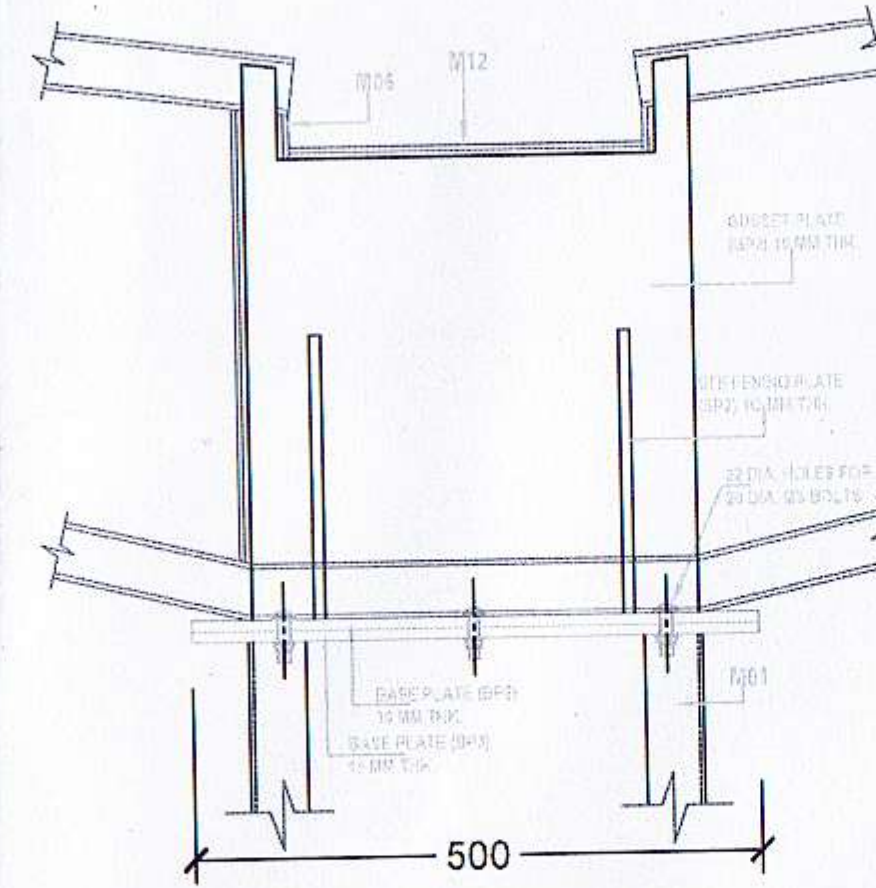

VIEW D1-D1 THROUGH THE BASE PLATE (BP2)

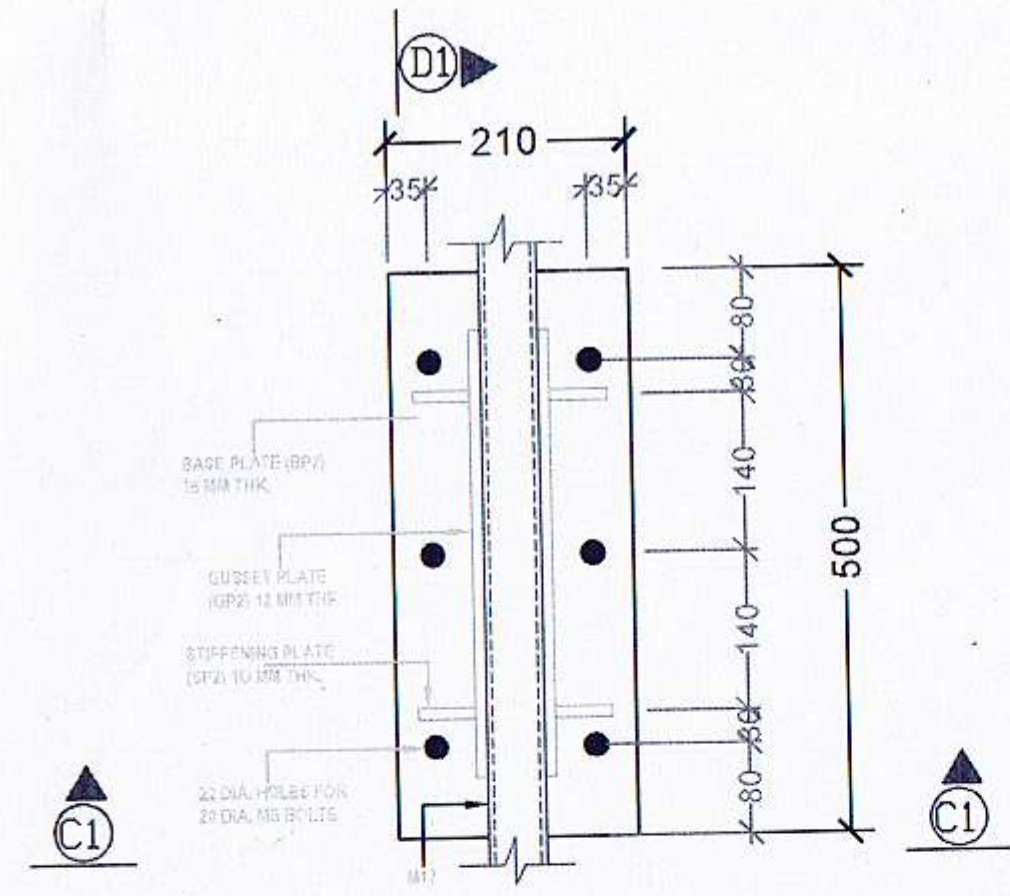

LAYOUT OF BASE PLATE (BP2) AT THE COLUMN

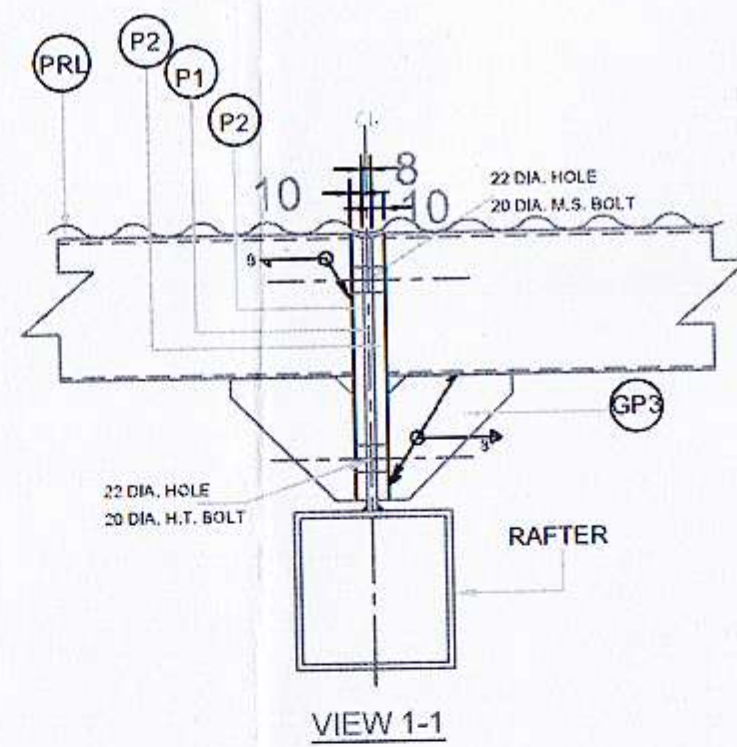

VIEW 1-1

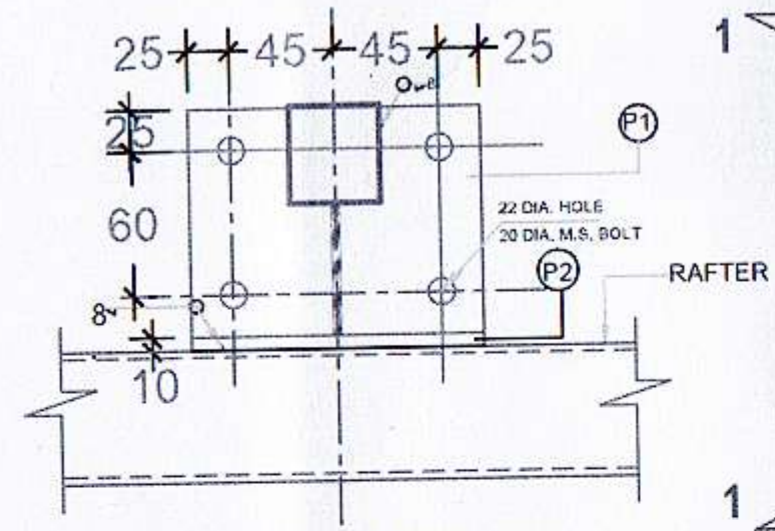

CONNECTION BETWEEN PURLIN & TRUSS T1

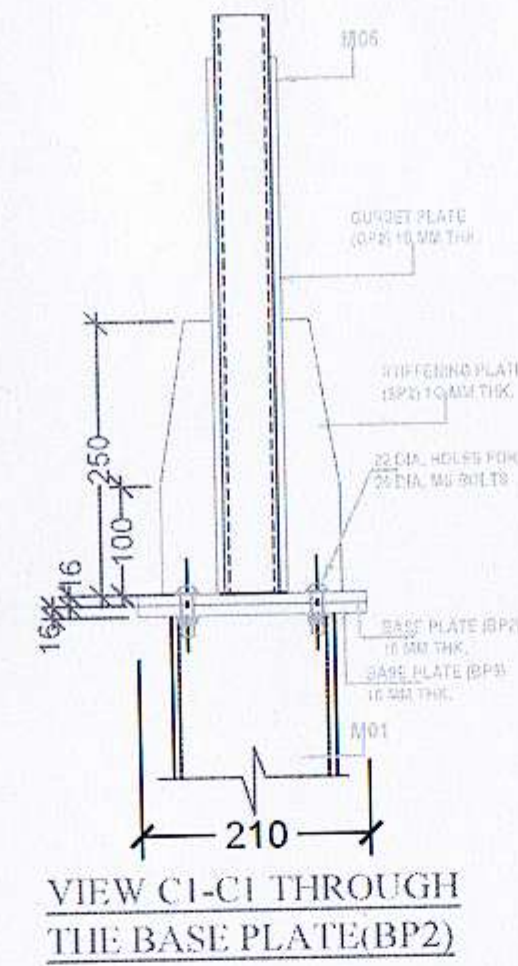

VIEW C1-C1 THROUGH THE BASE PLATE (BP2)

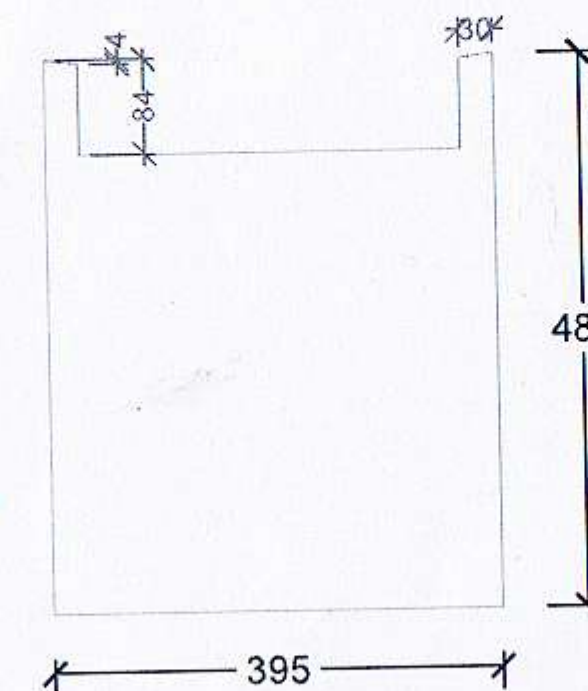

CUTTING DETAIL OF GUSSET PLATE (GP2)

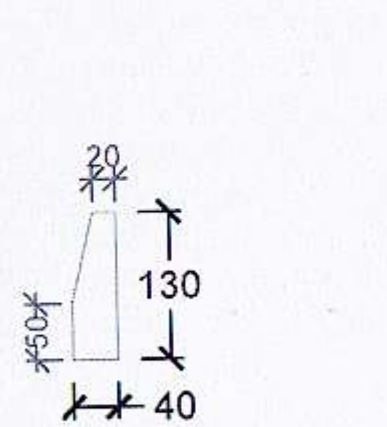

CUTTING DETAIL OF STIFFENING PLATE (SP1)

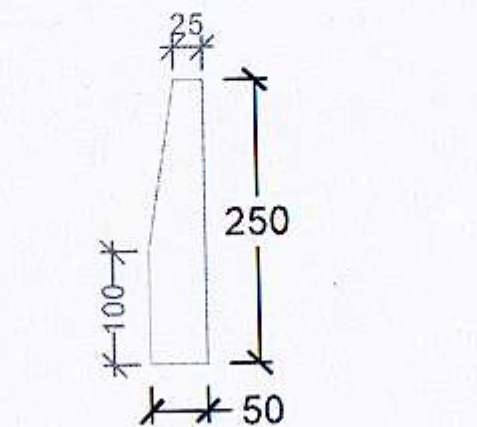

CUTTING DETAIL OF STIFFENING PLATE (SP2)

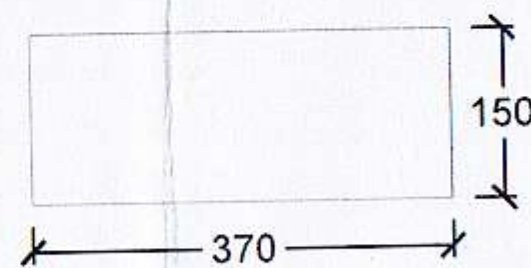

CUTTING DETAIL OF PLATE (P3)

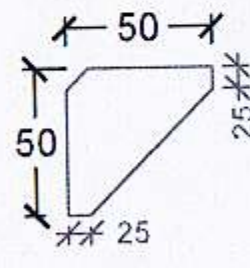

CUTTING DETAIL OF GUSSET PLATE (GP3)

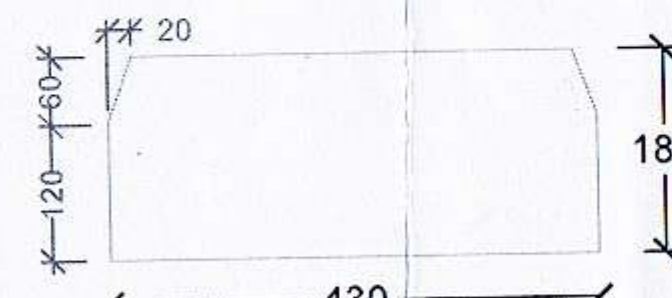

CUTTING DETAIL OF GUSSET PLATE (GP1)

- NOTES:-**
1. ALL DIMENSIONS ARE IN MM AND LEVELS/ELEVATIONS IN M UNLESS OTHERWISE MENTIONED.
 2. ALL LEVELS SHOWN ON DRAWINGS CORRESPONDS TO ACTUAL ELEVATIONS ABOVE MSL UNLESS NOTED OTHERWISE.
 3. DRAWINGS ARE NOT TO BE SCALED AND ONLY FIGURED DIMENSIONS TO BE FOLLOWED.
 4. ELEVATIONS REFER TO THE TOP OF STEEL WORK.
 5. ALL WELDING SHALL BE DONE AS PER IS:823 USING ELECTRODES OF APPROVED MANUFACTURER & CONFORMING TO IS:814.
 6. ALL CONNECTIONS EXCEPT SHOWN OTHERWISE ARE WELDED AND ALL WELDS ARE 6mm FILLET WELD ALLROUND.
 7. ALL SHOP WELDED CONNECTIONS SHALL BE FULL STRENGTH WELD UNLESS NOTED OTHERWISE.
 8. BATTENS, LACINGS, BOX & SECTIONS ETC. SHALL ALWAYS BE FULL WELDED UNLESS NOTED OTHERWISE.
 9. WELDING SYMBOLS WHERE USED ARE IN ACCORDANCE WITH IS:813.
 10. FOR ANCHOR BOLTS, THE HOLE DIAMETERS SHALL BE 3mm LARGER THAN THE BOLT DIA. UPTO 24mm DIA. BOLT 5mm MORE FOR BOLTS ABOVE 24mm.
 11. ALL GUSSETS FOR BOLTED OR WELDED CONNECTION ARE 10mm THICK UNLESS SPECIFIED OTHERWISE.
 12. ALL STRUCTURAL STEEL PLATE AND FLATS (UP TO 20mm) SHALL BE MILD STEEL OF GENERAL WELDED QUALITY CONFORMING TO IS 226. STRUCTURAL PLATE AND FLAT MATERIALS MORE THAN 20mm THICK SHALL CONFORM TO IS: 2062.
 13. STRUCTURAL SPECIFICATION SHALL BE AS PER TECHNICAL SPECIFICATION OF THE WORK.
 14. SURFACE PREPARATION, PRIMER AND FINISHED PAINTING SHALL CONFIRM TO TECHNICAL SPECIFICATION OF THE WORK.
 15. ERECTION BOLTS:
FOR ISA SECTIONS : 12 MM DIA ERECTION BOLT IN 13.5 MM DIA HOLE WILL BE PROVIDED WITH MIN. EDGE DISTANCE OF 50MM AND TYPICAL PITCH OF 100MM UNLESS OTHERWISE MENTIONED.
FOR ISMB / ISMC SECTIONS : 16 MM DIA ERECTION BOLT IN 18.5 MM DIA HOLE WILL BE PROVIDED WITH MIN. EDGE DISTANCE OF 50MM AND TYPICAL PITCH OF 100MM UNLESS OTHERWISE MENTIONED.

ISSUED FOR EXECUTION		
PRELIMINARY ISSUE FOR TENDER		
ISSUED FOR	DATE	
PROPOSED CONSTRUCTION OF CAR PARKING SHED AT ASSAM WATER CENTRE		
DRAWING:-		
GENERAL DETAIL ARRANGEMENT OF SUB-STRUCTURE AND SUPERSTRUCTURE FOR PARKING SHED 1 & 2		
OFFICE :		
FLOOD AND RIVER EROSION MANAGEMENT AGENCY OF ASSAM, BASISTHA, GUWAHATI-29		
ARCHITECT	DRG NO :	
SAMIUL JAHANGIR CA/2015/67214 Dy.EO(ARCH)	SJ/AWC/PARKING/02	
FREMAA 4TH FLOOR, ASSAM WATER CENTRE BASISTHA, GUWAHATI		
DRWN & CHK BY:	SCALE:	
SAMIUL JAHANGIR	NTS	
AEO(T), FREMAA	Dy.EO(ARCH), FREMAA	CTO, FREMAA
SIGNATURE	SIGNATURE	SIGNATURE

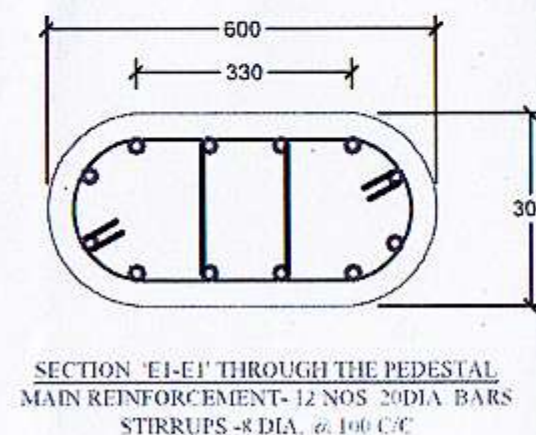
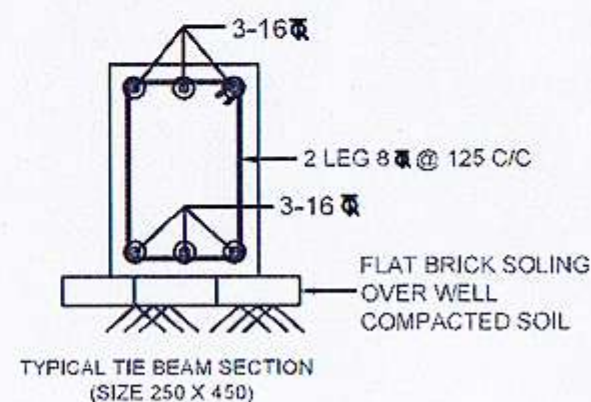
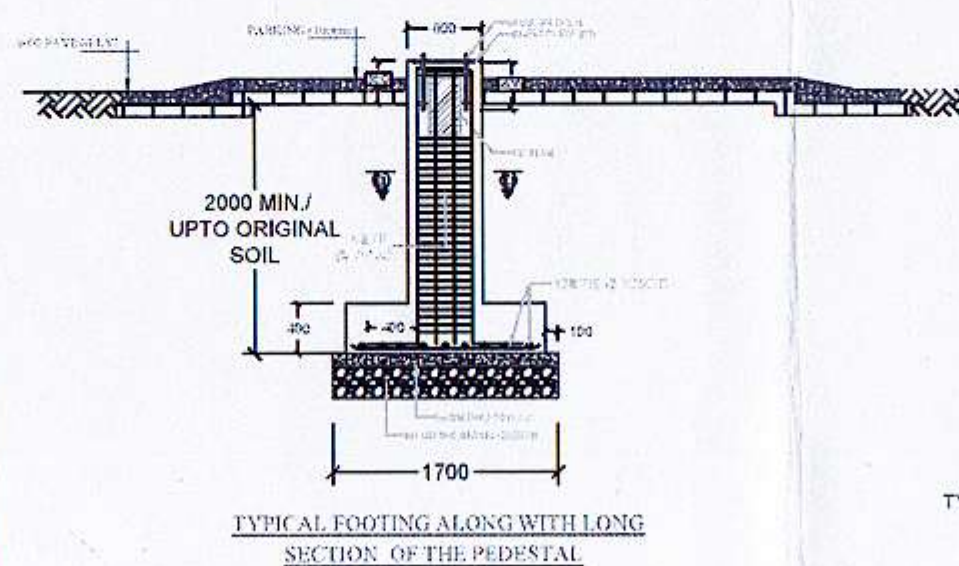
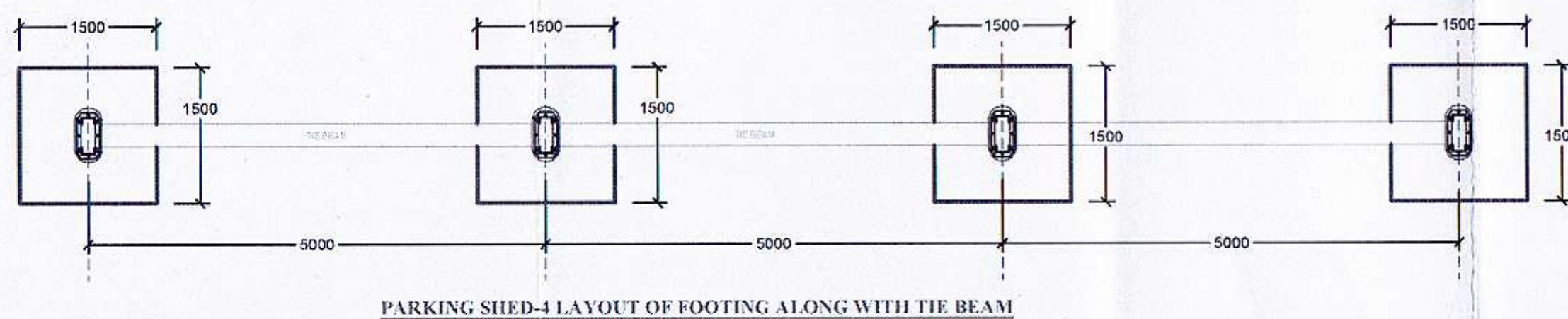
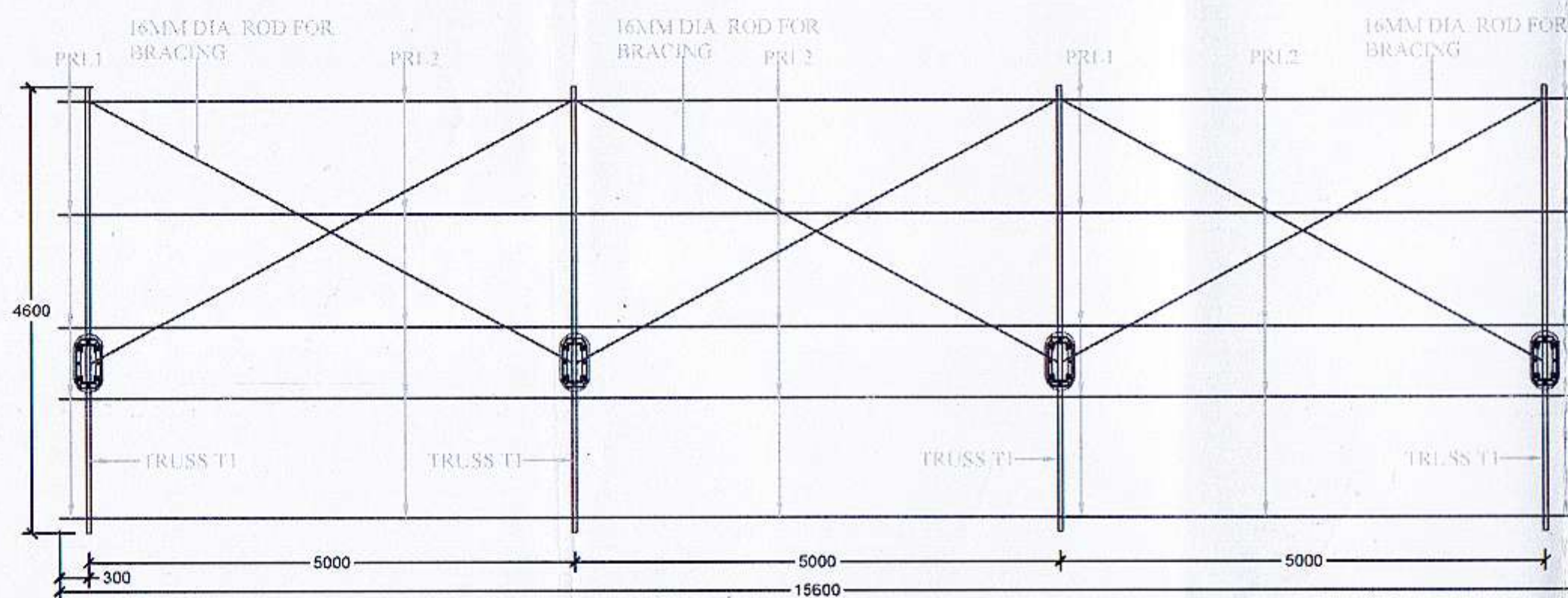
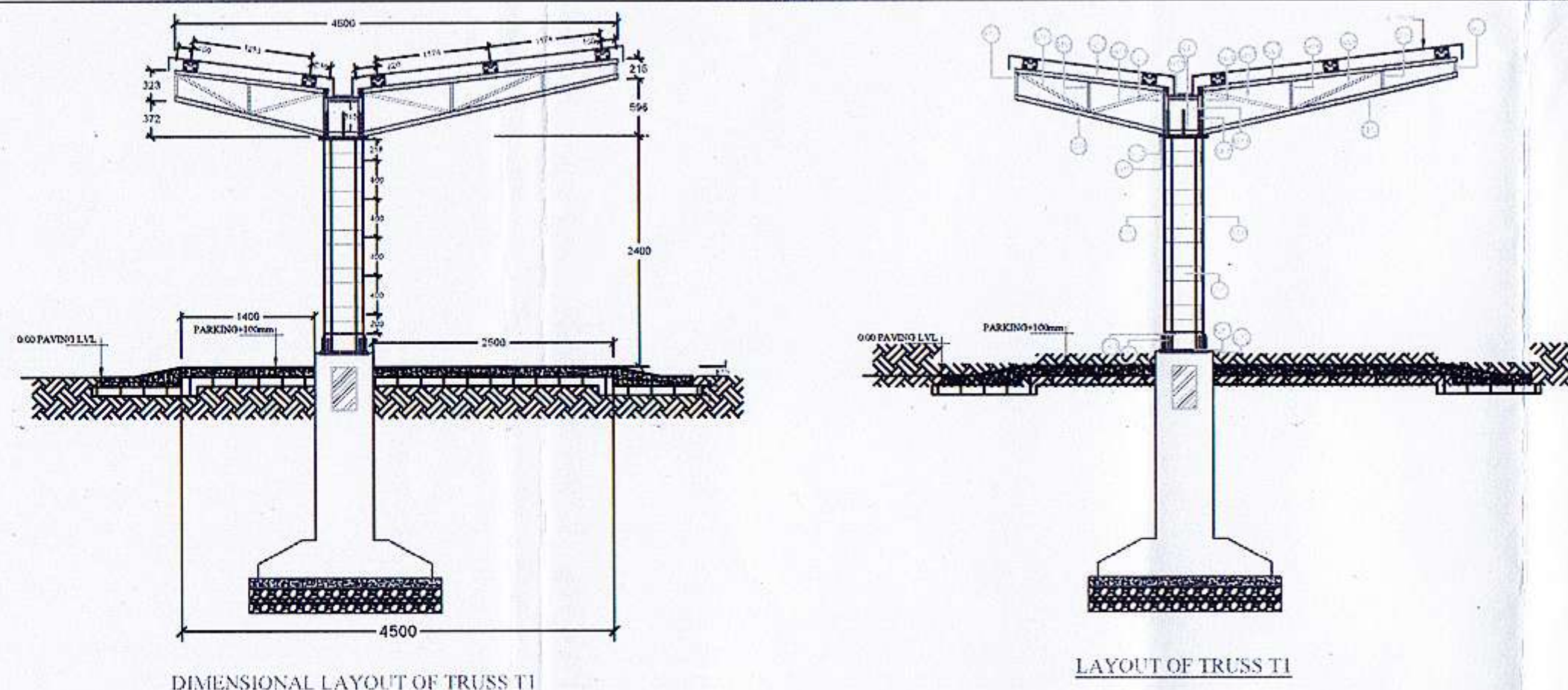

- NOTES:-**
1. ALL DIMENSIONS ARE IN MM AND LEVELS/ELEVATIONS IN M UNLESS OTHERWISE MENTIONED.
 2. ALL LEVELS SHOWN ON DRAWINGS CORRESPONDS TO ACTUAL ELEVATIONS ABOVE MSL UNLESS NOTED OTHERWISE.
 3. DRAWINGS ARE NOT TO BE SCALED AND ONLY FIGURED DIMENSIONS TO BE FOLLOWED.
 4. ELEVATIONS REFER TO THE TOP OF STEEL WORK.
 5. ALL WELDING SHALL BE DONE AS PER IS:823 USING ELECTRODES OF APPROVED MANUFACTURER & CONFORMING TO IS:814.
 6. ALL CONNECTIONS EXCEPT SHOWN OTHERWISE ARE WELDED AND ALL WELDS ARE 6mm FILLET WELD ALLROUND.
 7. ALL SHOP WELDED CONNECTIONS SHALL BE FULL STRENGTH WELD UNLESS NOTED OTHERWISE.
 8. BATTENS, LACINGS, BOX & SECTIONS ETC. SHALL ALWAYS BE FULL WELDED UNLESS NOTED OTHERWISE.
 9. WELDING SYMBOLS WHERE USED ARE IN ACCORDANCE WITH IS:813.
 10. FOR ANCHOR BOLTS, THE HOLE DIAMETERS SHALL BE 3mm LARGER THAN THE BOLT DIA. UPTO 24mm DIA. BOLT 5mm MORE FOR BOLTS ABOVE 24mm.
 11. ALL GUSSETS FOR BOLTED OR WELDED CONNECTION ARE 10mm THICK UNLESS SPECIFIED OTHERWISE.
 12. ALL STRUCTURAL STEEL PLATE AND FLATS (UP TO 20mm) SHALL BE MILD STEEL OF GENERAL WELDED QUALITY CONFORMING TO IS 226. STRUCTURAL PLATE AND FLAT MATERIALS MORE THAN 20mm THICK SHALL CONFORM TO IS: 2062.
 13. STRUCTURAL SPECIFICATION SHALL BE AS PER TECHNICAL SPECIFICATION OF THE WORK.
 14. SURFACE PREPARATION, PRIMER AND FINISHED PAINTING SHALL CONFIRM TO TECHNICAL SPECIFICATION OF THE WORK.
 15. ERECTION BOLTS:
FOR ISA SECTIONS : 12 MM DIA ERECTION BOLT IN 13.5 MM DIA HOLE WILL BE PROVIDED WITH MIN. EDGE DISTANCE OF 50MM AND TYPICAL PITCH OF 100MM UNLESS OTHERWISE MENTIONED.
FOR ISMB / ISMC SECTIONS : 16 MM DIA ERECTION BOLT IN 18.5 MM DIA HOLE WILL BE PROVIDED WITH MIN. EDGE DISTANCE OF 50MM AND TYPICAL PITCH OF 100MM UNLESS OTHERWISE MENTIONED.

ISSUED FOR EXECUTION	
PRELIMINARY ISSUE FOR TENDER	
ISSUED FOR	DATE

PROPOSED CONSTRUCTION OF CAR PARKING SHED AT ASSAM WATER CENTRE

**DRAWING:-
GENERAL ARRANGEMENT OF SUB-STRUCTURE AND SUPERSTRUCTURE FOR PARKING SHED 1 & 2**

OFFICE:
FLOOD AND RIVER EROSION MANAGEMENT AGENCY OF ASSAM, BASISTHA, GUWAHATI-29

ARCHITECT	DRG NO :	
SAMIUL JAHANGIR CA/2015/67214 Dy.EO(ARCH)	SJ/AWC/PARKING/02	
FREMAA 4TH FLOOR, ASSAM WATER CENTRE BASISTHA, GUWAHATI		
DRWN & CHK BY:	SCALE:	
SAMIUL JAHANGIR	NTS	
AEO(T),FREMAA	Dy.EO(ARCH),FREMAA	CTO,FREMAA
SIGNATURE	SIGNATURE	SIGNATURE

Performance Security - Bank Guarantee

[Guarantor letterhead or SWIFT identifier code]

Performance Guarantee No.....*[insert guarantee reference number]*

Date.....*[insert date of issue of the guarantee]*

To: _____ *[name of Client]*

_____ *[address of Client]*

WHEREAS _____ *[name and address of Supplier¹]* (hereinafter called "the Applicant") has undertaken, in pursuance of Contract No. _____ dated _____ to execute _____ *[name of Contract and brief description of Goods and related Services]* (hereinafter called "the Contract");

AND WHEREAS it has been stipulated by you in the said Contract that the Applicant shall furnish you with a Bank Guarantee by a recognized bank for the sum specified therein as security for compliance with his obligations in accordance with the Contract;

AND WHEREAS we have agreed to give the Applicant such a Bank Guarantee;

NOW THEREFORE we hereby affirm that we are the Guarantor and responsible to you, on behalf of the Applicant, up to a total of _____ *[amount of guarantee²]* _____ *[in words]*, such sum being payable in the types and proportions of currencies in which the Contract Price is payable, and we undertake to pay you, upon your first written demand and without cavil or argument, any sum or sums within the limits of _____ *[amount of guarantee]* as aforesaid without your needing to prove or to show grounds or reasons for your demand for the sum specified therein.

We hereby waive the necessity of your demanding the said debt from the Applicant before presenting us with the demand.

¹*In the case of a JV, insert the name of the Joint Venture*

²*An amount shall be inserted by the Guarantor, representing the percentage of the Contract Price specified in the Contract and denominated in Indian Rupees.*

We further agree that no change or addition to or other modification of the terms of the Contract or of the Goods and related Services to be supplied there under or of any of the Contract documents which may be made between you and the Applicant shall in any way release us from any liability under this guarantee, and we hereby waive notice of any such change, addition or modification.

This guarantee shall be valid until (i.e.) 45 days following the Completion date of the Contract including any warranty obligations, and any demand for payment under it must be received by us at this office on or before that date.

Signature and seal of the guarantor _____

Name of Bank _____

Address _____

Date _____

Note: All italicized text (including footnotes) is for use in preparing this form and shall be deleted from the final product.